

LÍNEA KEY WEST MODELO | K5

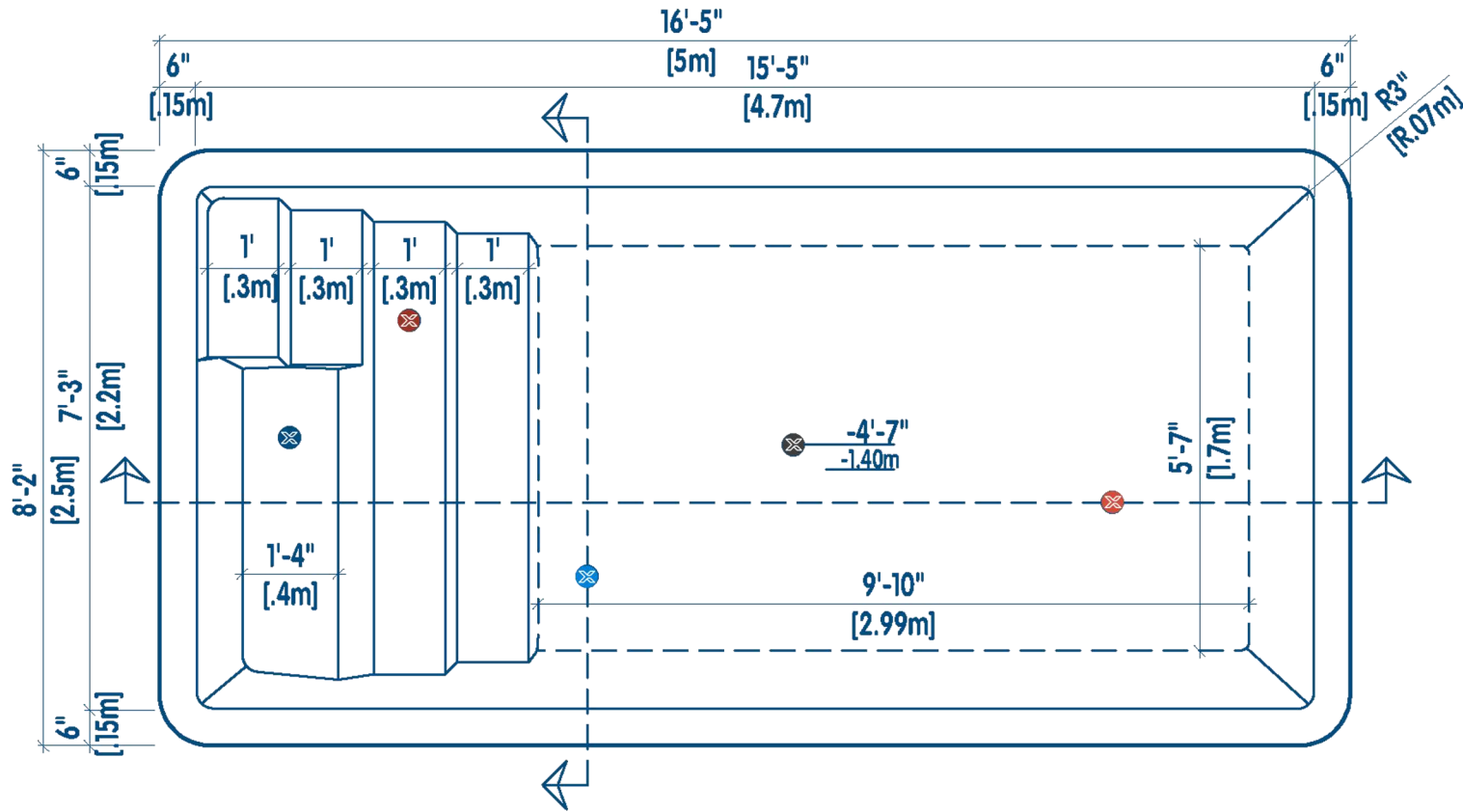

- STAIRS
- BENCH
- DEPTH
- LONGITUDINAL SECTION
- CROSS SECTION
- INTERNAL MEASURE
- WATER LEVEL
- GROOVE

NOTE
-NO ESCALE
THIS MODEL PRESENTS:
-BRACKETS ALONG THE EDGE AND
REINFORCEMENTS DISTRIBUTED AT
A MEDIUM DISTANCE OF 45 CM.

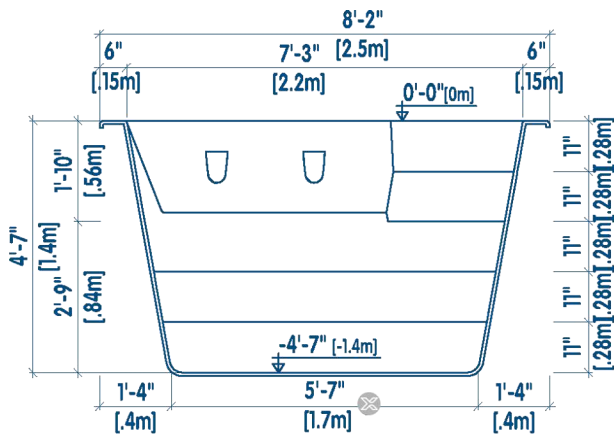

CORTE TRANSVERSAL
| CROSS SECTION

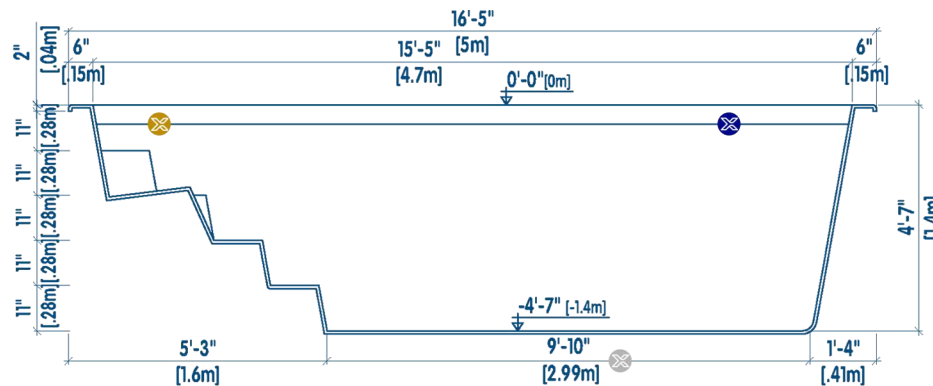

CORTE LONGITUDINAL
| LONGITUDINAL SECTION

- ESCALONES | ESCALERA
- BANCO
- PROFUNDIDAD
- CORTE LONGITUDINAL
- CORTE TRANSVERSAL
- MEDIDA INTERNA
- NÍVEL DE AGUA
- CAVIDAD

NOTA
-NO ESCALA
ESTE MODELO PRESENTA:
-SOPORTES A LO LARGO DEL BORDE
Y REFUERZOS DISTRIBUIDOS A UNA
DISTANCIA MEDIA DE 45 CM.

LÍNEA KEY WEST MODELO | K8

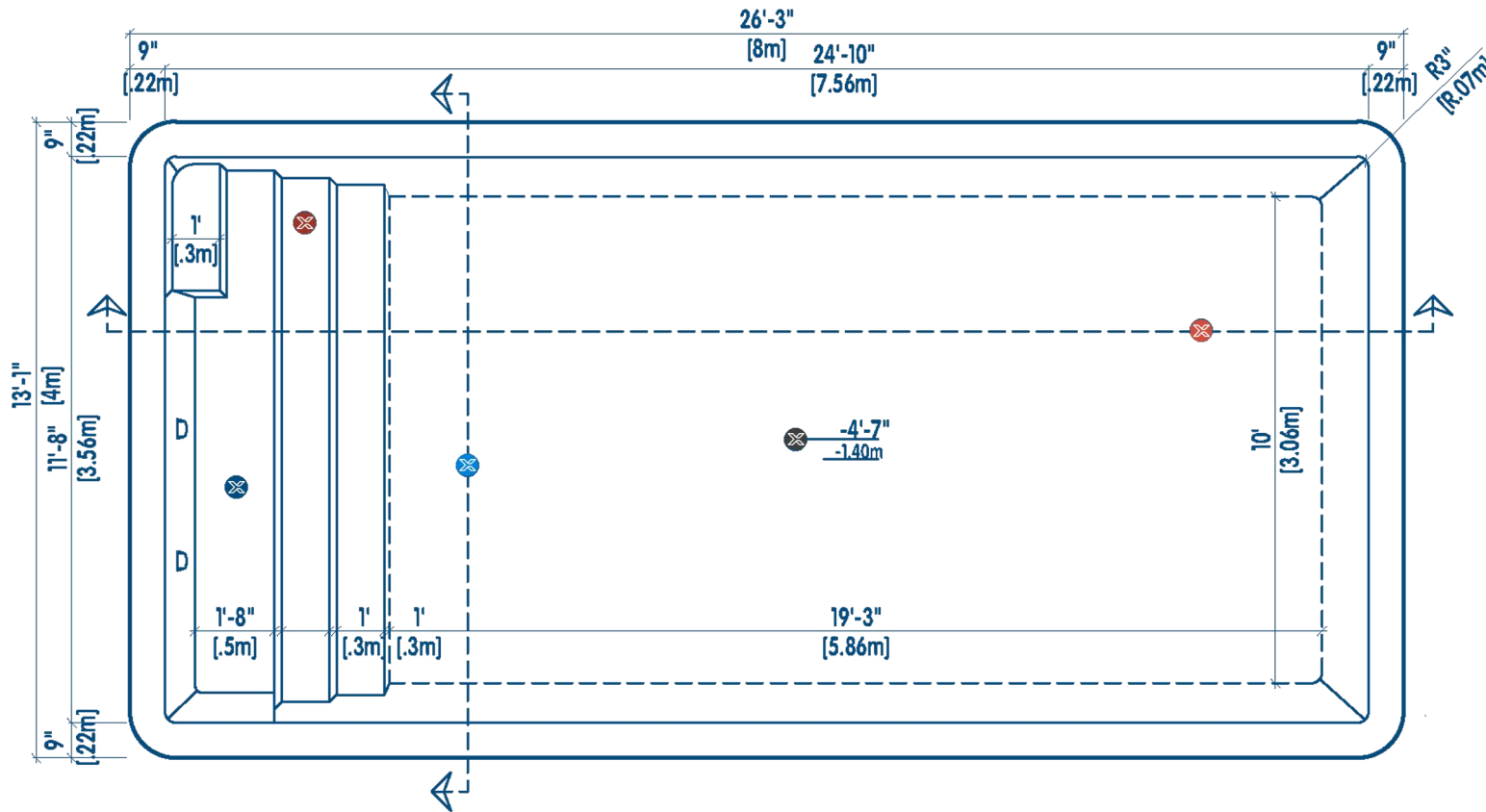

- STAIRS
- BENCH
- DEPTH
- LONGITUDINAL SECTION
- CROSS SECTION
- INTERNAL MEASURE
- WATER LEVEL
- GROOVE

NOTE
-NO ESCALE
THIS MODEL PRESENTS:
-BRACKETS ALONG THE EDGE AND
REINFORCEMENTS DISTRIBUTED AT
A MEDIUM DISTANCE OF 45 CM.

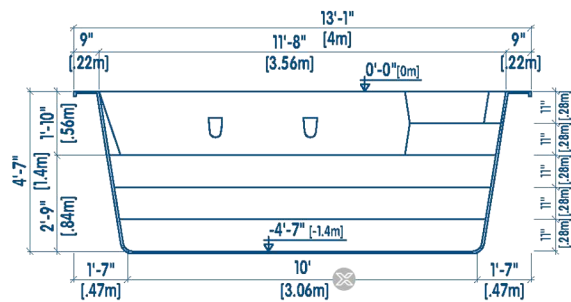

CORTE TRANSVERSAL
| CROSS SECTION

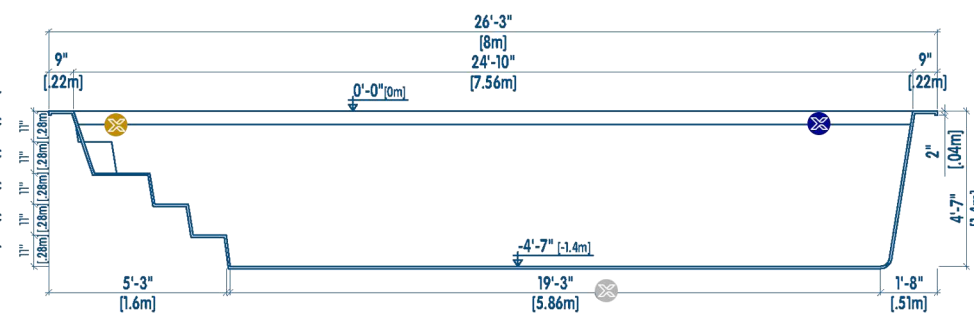







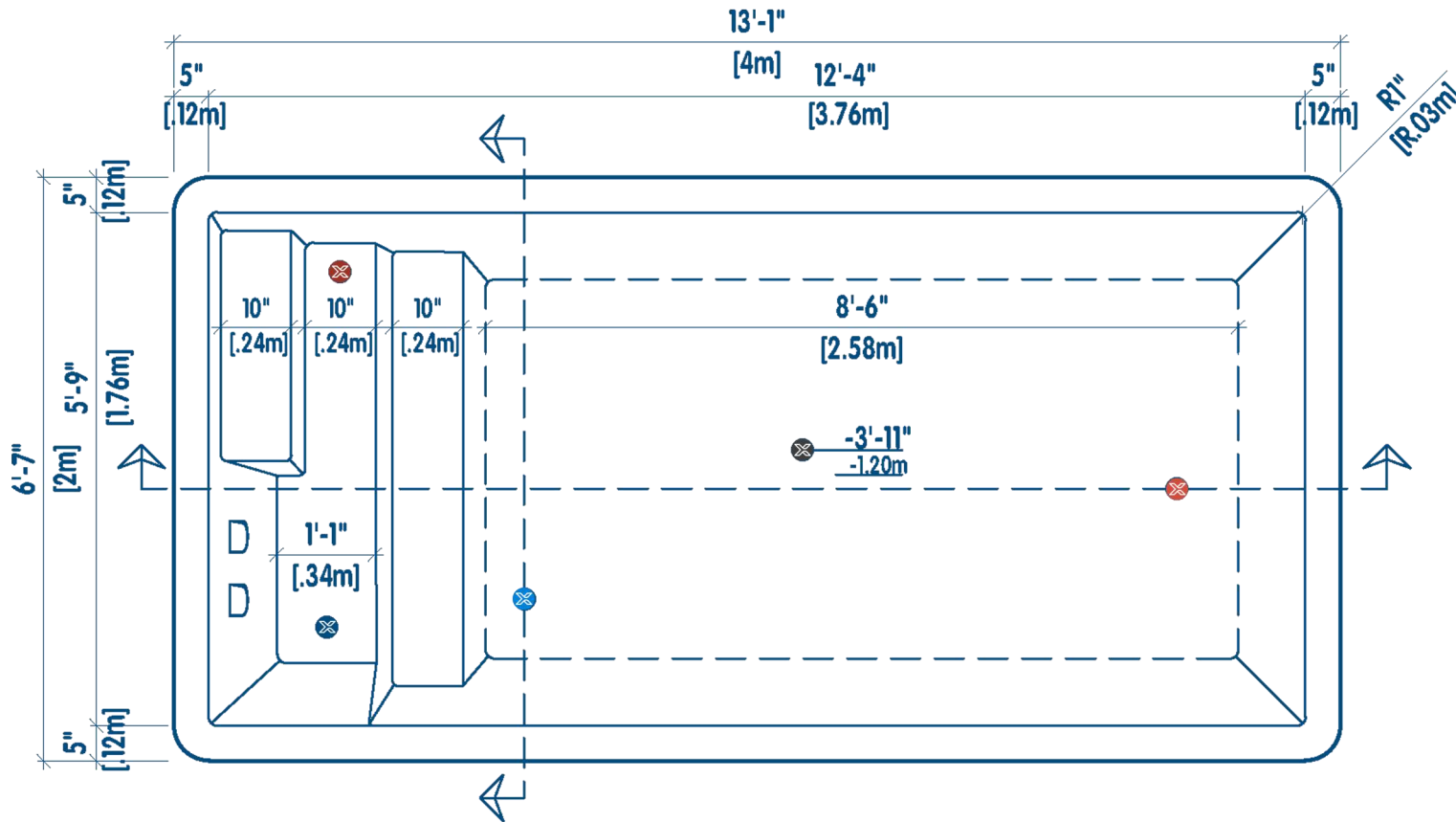

CORTE LONGITUDINAL
| LONGITUDINAL SECTION

- ESCALONES | ESCALERA
- BANCO
- PROFUNDIDAD
- CORTE LONGITUDINAL
- CORTE TRANSVERSAL
- MEDIDA INTERNA
- NÍVEL DE AGUA
- CAVIDAD

NOTA
-NO ESCALA
ESTE MODELO PRESENTA:
-SOPORTES A LO LARGO DEL BORDE
Y REFUERZOS DISTRIBUIDOS A UNA
DISTANCIA MEDIA DE 45 CM.







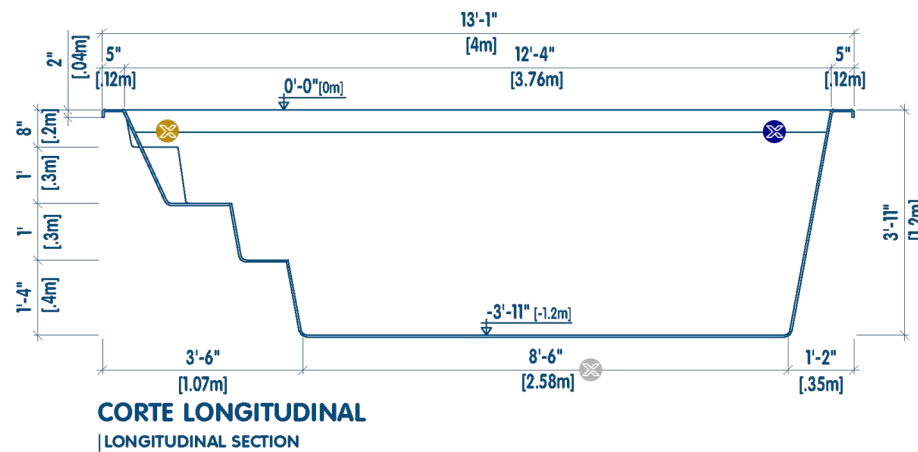
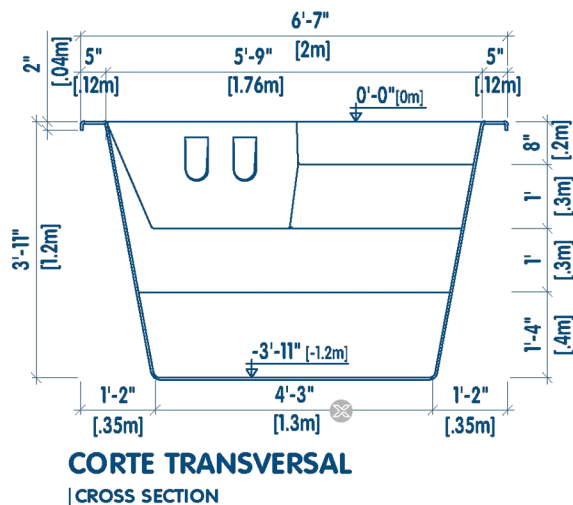

LÍNEA KEY WEST MODELO | K4



-  STAIRS
-  BENCH
-  DEPTH
-  LONGITUDINAL SECTION
-  CROSS SECTION
-  INTERNAL MEASURE
-  WATER LEVEL
-  GROOVE

NOTE
-NO ESCALE
THIS MODEL PRESENTS:
-BRACKETS ALONG THE EDGE AND
REINFORCEMENTS DISTRIBUTED AT
A MEDIUM DISTANCE OF 45 CM.









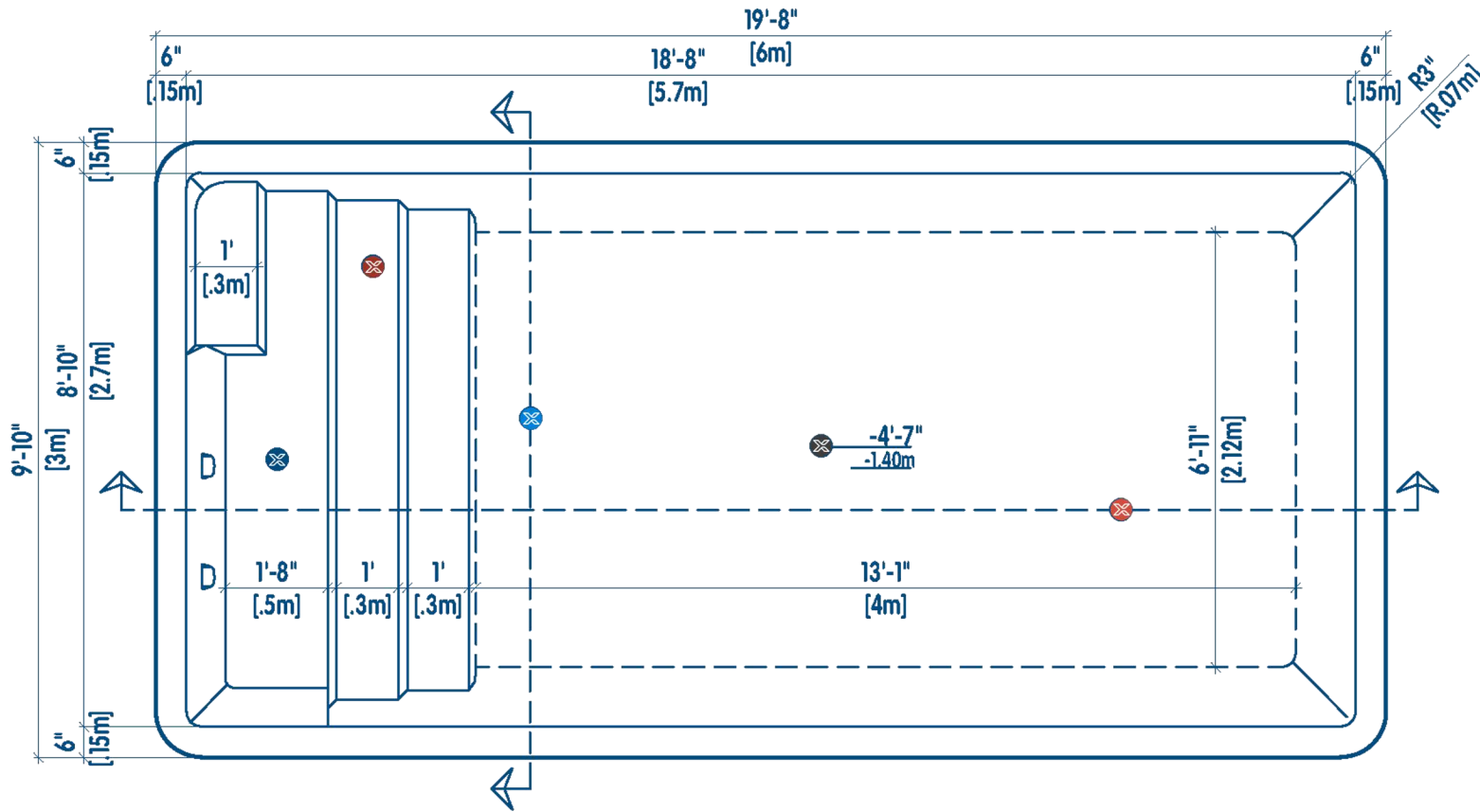

-  ESCALONES | ESCALERA
-  BANCO
-  PROFUNDIDAD
-  CORTE LONGITUDINAL
-  CORTE TRANSVERSAL
-  MEDIDA INTERNA
-  NÍVEL DE AGUA
-  CAVIDAD

NOTA
-NO ESCALA
ESTE MODELO PRESENTA:
-SOPORTES A LO LARGO DEL BORDE
Y REFUERZOS DISTRIBUIDOS A UNA
DISTANCIA MEDIA DE 45 CM.

LÍNEA KEY WEST MODELO | K6



-  STAIRS
-  BENCH
-  DEPTH
-  LONGITUDINAL SECTION
-  CROSS SECTION
-  INTERNAL MEASURE
-  WATER LEVEL
-  GROOVE



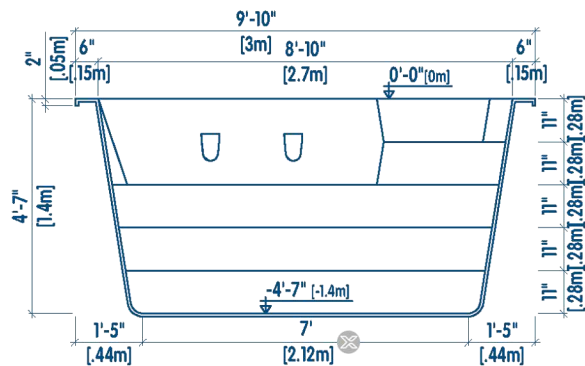



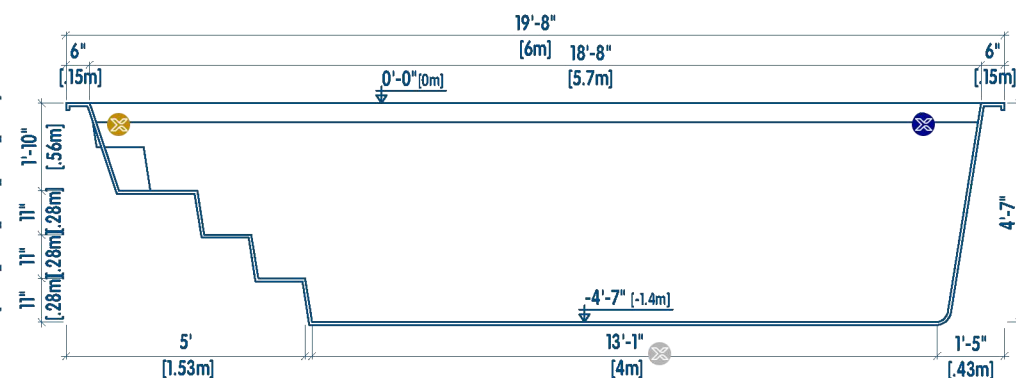

NOTE
-NO ESCALE
THIS MODEL PRESENTS:
-BRACKETS ALONG THE EDGE AND
REINFORCEMENTS DISTRIBUTED AT
A MEDIUM DISTANCE OF 45 CM.



CORTE TRANSVERSAL
| CROSS SECTION



CORTE LONGITUDINAL
| LONGITUDINAL SECTION

-  ESCALONES | ESCALERA
-  BANCO
-  PROFUNDIDAD
-  CORTE LONGITUDINAL
-  CORTE TRANSVERSAL
-  MEDIDA INTERNA
-  NÍVEL DE AGUA
-  CAVIDAD

NOTA
-NO ESCALA
ESTE MODELO PRESENTA:
-SOPORTES A LO LARGO DEL BORDE
Y REFUERZOS DISTRIBUIDOS A UNA
DISTANCIA MEDIA DE 45 CM.



LÍNEA KEY WEST MODELO | K7

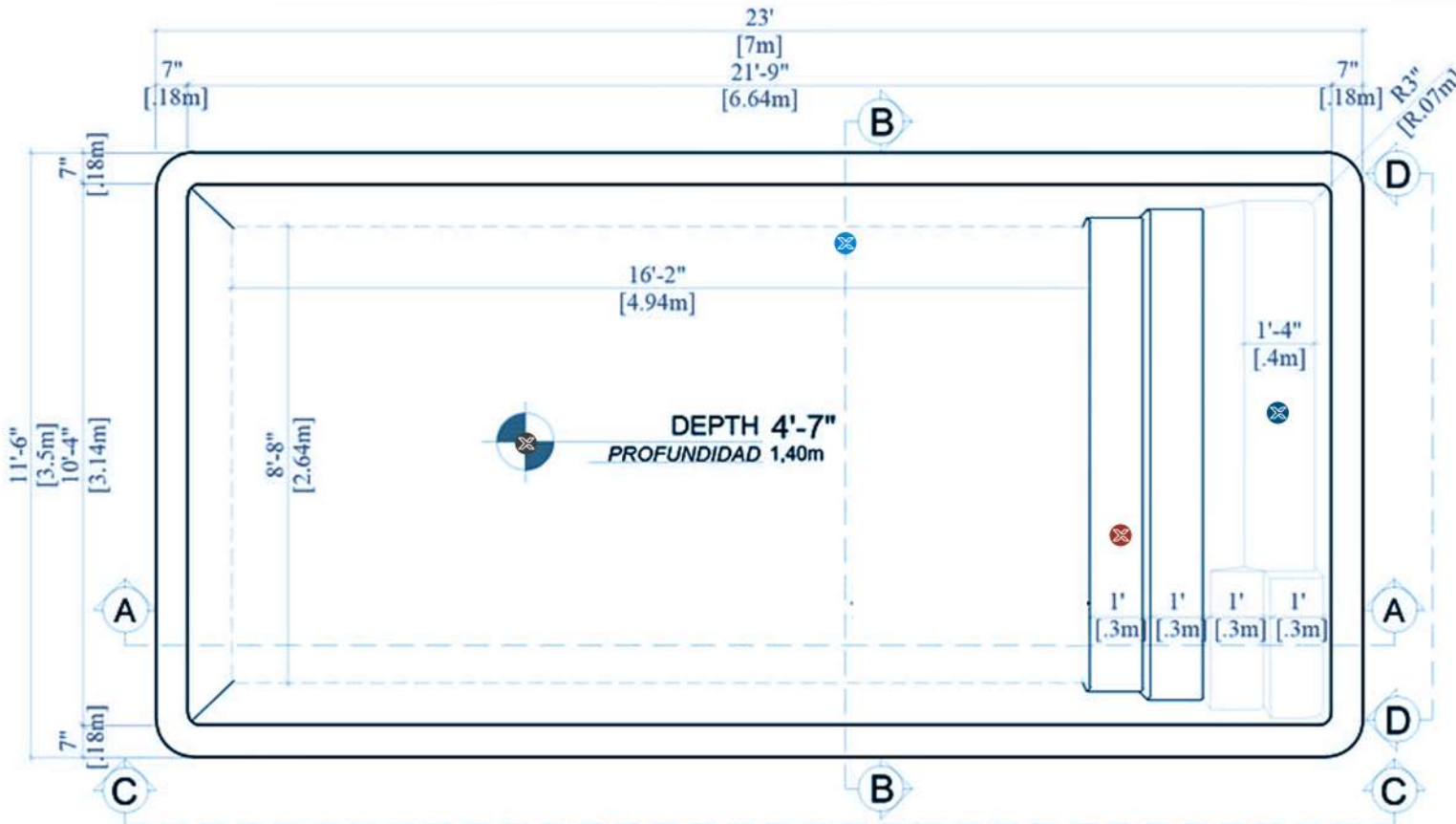

- STAIRS
- BENCH
- DEPTH
- LONGITUDINAL SECTION
- CROSS SECTION
- INTERNAL MEASURE
- WATER LEVEL
- GROOVE

NOTE
-NO ESCALE
THIS MODEL PRESENTS:
-BRACKETS ALONG THE EDGE AND
REINFORCEMENTS DISTRIBUTED AT
A MEDIUM DISTANCE OF 45 CM.

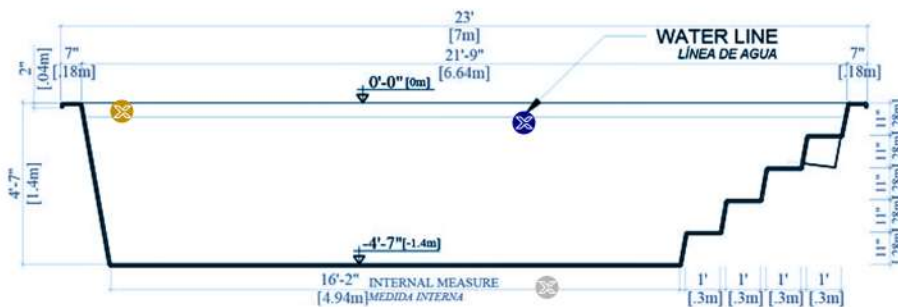
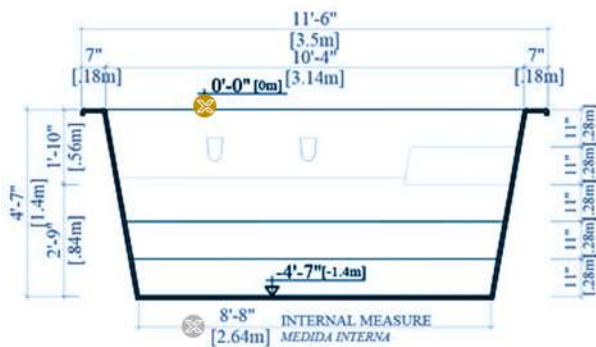

- ESCALONES | ESCALERA
- BANCO
- PROFUNDIDAD
- CORTE LONGITUDINAL
- CORTE TRANSVERSAL
- MEDIDA INTERNA
- NÍVEL DE AGUA
- CAVIDAD

NOTA
-NO ESCALA
ESTE MODELO PRESENTA:
-SOPORTES A LO LARGO DEL BORDE
Y REFUERZOS DISTRIBUIDOS A UNA
DISTANCIA MEDIA DE 45 CM.