

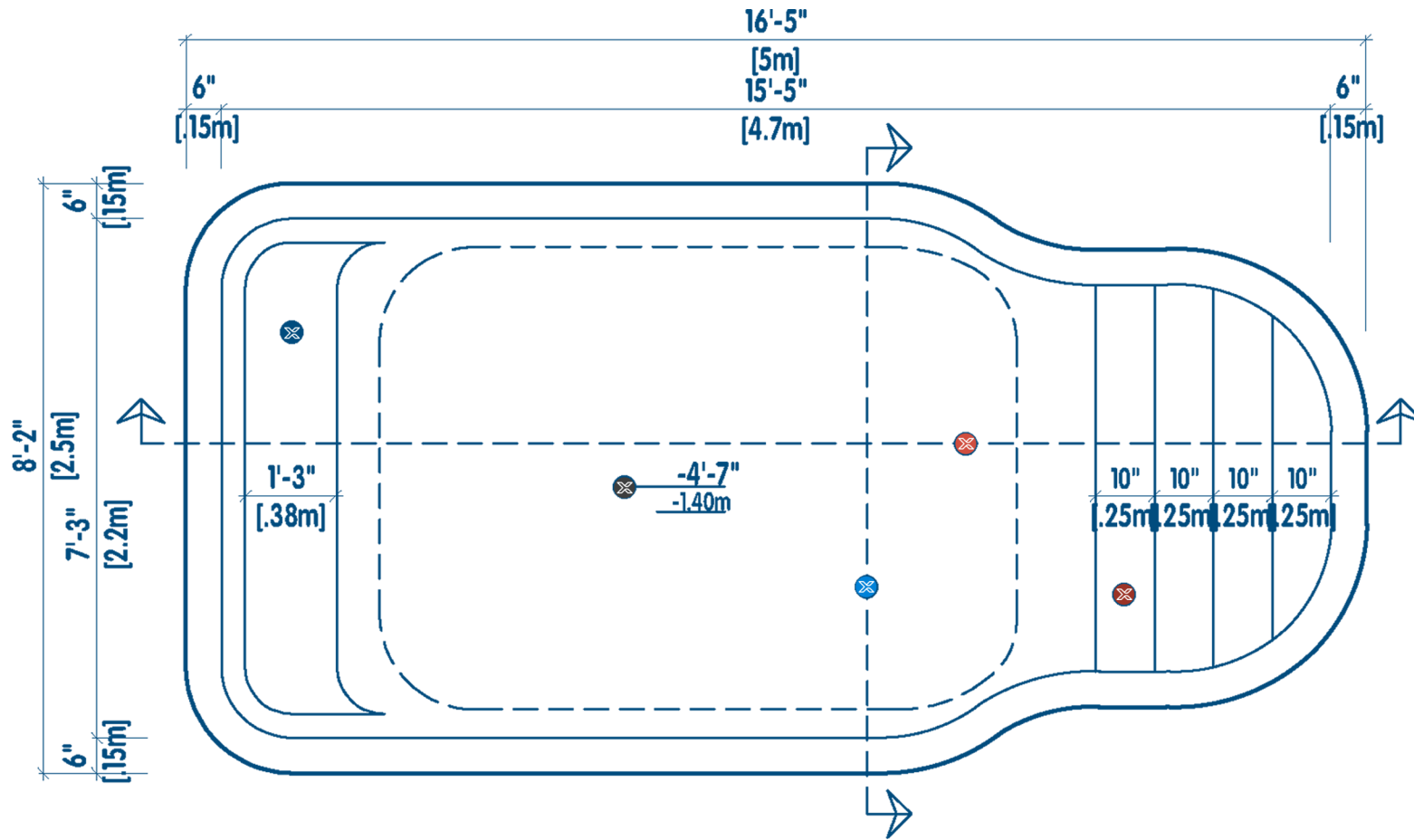

LÍNEA DAYTONA BEACH MODELO | D5



- STAIRS
- BENCH
- DEPTH
- LONGITUDINAL SECTION
- CROSS SECTION
- INTERNAL MEASURE
- WATER LEVEL

NOTE

-NO ESCALE
THIS MODEL PRESENTS:
-BRACKETS ALONG THE EDGE AND
REINFORCEMENTS DISTRIBUTED AT
A MEDIUM DISTANCE OF 45 CM.

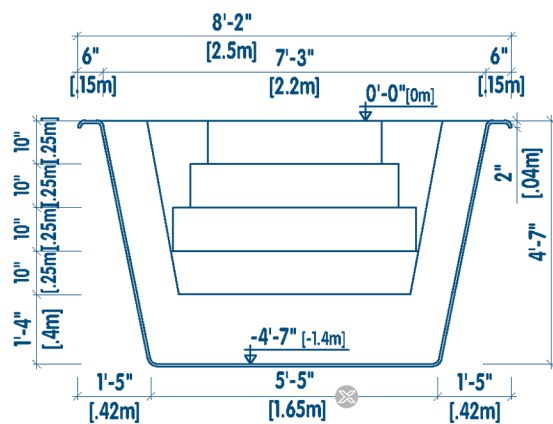

CORTE TRANSVERSAL
| CROSS SECTION

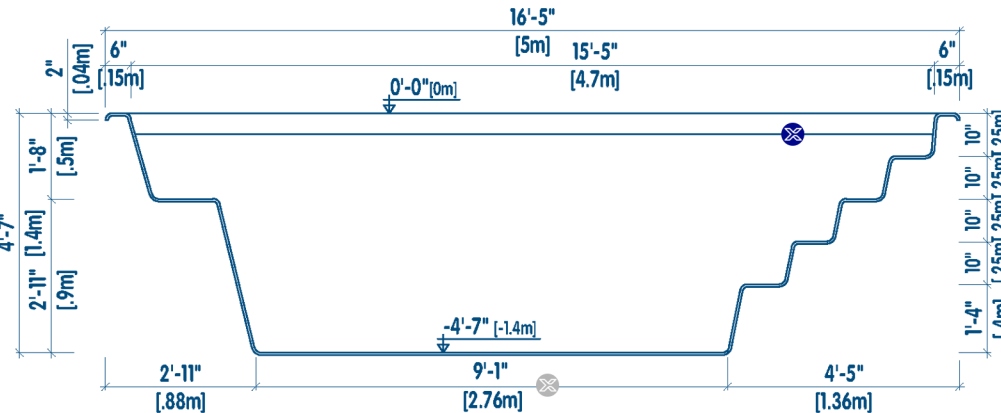

CORTE LONGITUDINAL
| LONGITUDINAL SECTION

- ESCALONES | ESCALERA
- BANCO
- PROFUNDIDAD
- CORTE LONGITUDINAL
- CORTE TRANSVERSAL
- MEDIDA INTERNA
- NÍVEL DE AGUA

NOTA

-NO ESCALA
ESTE MODELO PRESENTA:
-SOPORTES A LO LARGO DEL BORDE
Y REFUERZOS DISTRIBUIDOS A UNA
DISTANCIA MEDIA DE 45 CM.