

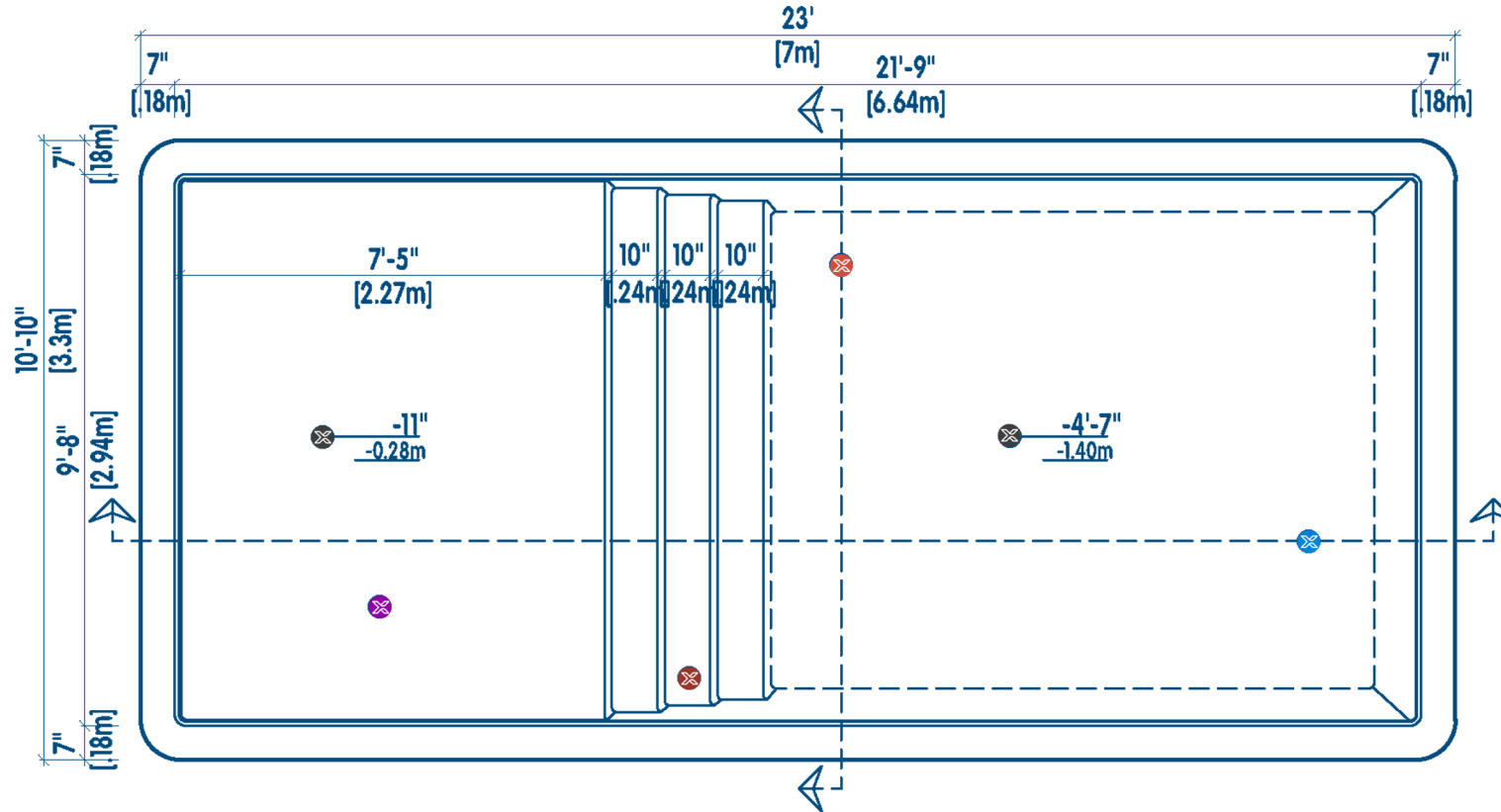

LÍNEA CALIFORNIA

MODELO | C7



- STAIRS
- DEPTH
- LONGITUDINAL SECTION
- CROSS SECTION
- INTERNAL MEASURE
- WATER LEVEL
- GROOVE
- TANNING LEDGE

NOTE
 -NO ESCALE
 THIS MODEL PRESENTS:
 -BRACKETS ALONG THE EDGE AND REINFORCEMENTS DISTRIBUTED AT A MEDIUM DISTANCE OF 45 CM.

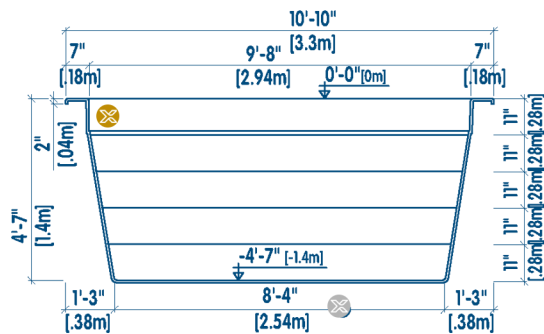

CORTE TRANSVERSAL
 | CROSS SECTION

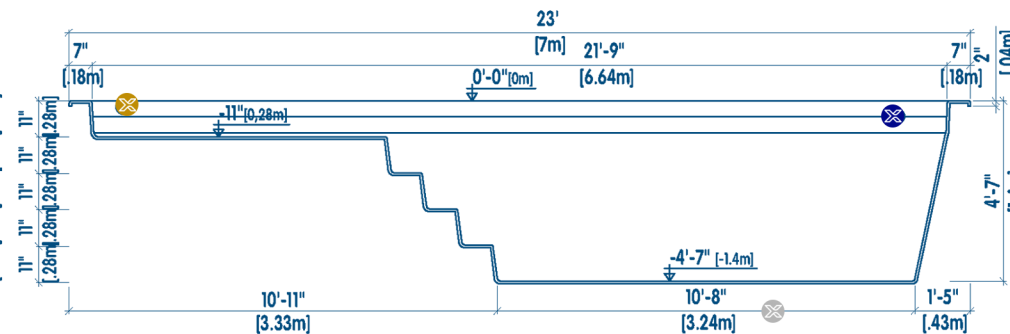

CORTE LONGITUDINAL
 | LONGITUDINAL SECTION

- ESCALONES | ESCALERA
- PROFUNDIDAD
- CORTE LONGITUDINAL
- CORTE TRANSVERSAL
- MEDIDA INTERNA
- NÍVEL DE AGUA
- CAVIDAD
- ÁREA DE BRONCEADO

NOTA
 -NO ESCALA
 ESTE MODELO PRESENTA:
 -SOPORTES A LO LARGO DEL BORDE Y REFUERZOS DISTRIBUIDOS A UNA DISTANCIA MEDIA DE 45 CM.